

# PSAN Series

## Small size, 1/2,000 resolution connector type digital pressure sensor

### Features

NEW

- High resolution : 1/1000, 1/2000 selectable
- Auto shift function : making stable output possible regardless of initial pressure change
- Hold function
- 2 independent output
- Forced-output mode embodied for easy operation test and monitoring
- One-touch connector type for easy maintenance
- Analog output function (voltage : 1-5V, current : 4-20mA)
- Zero adjustment function, Peak monitoring function
- Convertible pressure unit  
Vacuum pressure, Compound pressure :  
kPa, kgf/cm<sup>2</sup>, bar, psi, mmHg, mmH<sub>2</sub>O, inHg  
Standard pressure : kPa, kgf/cm<sup>2</sup>, bar, psi
- Various output modes : Hysteresis mode, Automatic sensitivity setting mode, Individual 2 output mode, Window comparative output mode
- Chattering prevention function  
(Selectable response time : 2.5, 5, 100, 500, 1000ms)



⚠ Please read "Caution for your safety" in operation manual before using.



### Ordering information

PS AN - V 01 C P V - Rc1/8

PS	AN	-	V	01	C	P	V	-	Rc1/8	
									Pressure port (★)	
									Option output(Function)	
									Output type	
									Cable	
									Pressure range	
									Pressure type	
									Appearance	
									Rc1/8	Standard
									NPT1/8	Option
			V						V	Analog voltage(1-5V) output
			A						A	Analog current(4-20mA) output
			H						H	Hold/Auto shift input
									Blank	NPN open collector output
									P	PNP open collector output
									C	Connector type
				01					01	100kPa
				1					1	1MPa
									Blank	Standard pressure type
									V	Vacuum pressure type
									C	Compound pressure type
									AN	Regular square New type(30mm×30mm)
									PS	Pressure Sensor

※(★)In case of using M5 port, use PSO-Z01 (M5 Gender) together.

### Pressure and Max. pressure display range

Type	kPa	kgf/cm <sup>2</sup>	bar	psi	mmHg	inHg	mmH <sub>2</sub> O
Vacuum pressure	0 ~ -101.3 (5.0 ~ -101.3)	0 ~ -1.033 (0.051 ~ -1.034)	0 ~ -1.013 (0.05 ~ -1.013)	0 ~ -14.70 (0.74 ~ -14.70)	0 ~ -760 (38 ~ -760)	0 ~ -29.9 (1.5 ~ -29.9)	0 ~ -103.4 (5.2 ~ -103.4)
Standard pressure	0 ~ 100.0 (-5.0 ~ 110.0)	0 ~ 1.020 (-0.051 ~ 1.122)	0 ~ 1.020 (-0.050 ~ 1.100)	0 ~ 14.50 (-0.726 ~ 15.96)	—	—	—
	0 ~ 1000 (-50 ~ 1100)	0 ~ 10.20 (-0.51 ~ 11.22)	0 ~ 10.00 (-0.50 ~ 11.00)	0 ~ 145.0 (-7.2 ~ 159.6)	—	—	—
Compound pressure	100.0 ~ -100.0 (110.0 ~ -101.2)	1.020 ~ -1.020 (1.122 ~ -1.034)	1.020 ~ -1.020 (1.100 ~ -1.012)	14.50 ~ -14.50 (15.96 ~ -14.70)	750 ~ -750 (824 ~ -760)	29.5 ~ -29.5 (32.6 ~ -29.9)	102.1 ~ -103.4 (112.3 ~ -103.4)

※( ) is Max. pressure display range.

※When using a unit mmH<sub>2</sub>O, please multiply display value by 100.

### Pressure conversion chart

from \ to	Pa	kPa	MPa	kgf/cm <sup>2</sup>	mmHg	mmH <sub>2</sub> O	psi	bar	inHg
1kPa	1000.000	1	0.001000	0.010197	7.500616	101.9689	0.145038	0.010000	0.2953
1kgf/cm <sup>2</sup>	98066.54	98.066543	0.09806	1	735.5595	10000.20	14.22334	0.980665	28.95878
1mmHg	133.322368	0.133322	0.000133	0.001359	1	13.5954	0.019336	0.001333	0.039370
1mmH <sub>2</sub> O	9.80665	0.00980	—	0.000099	0.0735578	1	0.00142	0.000098	0.002895
1psi	6894.757	6.89493	0.00689	0.070307	51.71630	703.07	1	0.068947	2.036074
1Pa	100000.0	100.0000	0.100000	1.019689	750.062	10196.89	14.50339	1	29.52998
1inHg	3386.417	3.386388	0.003386	0.034532	25.40022	345.31849	0.491158	0.033863	1

Ex)In case of calculating 760mmHg as kPa :

According to above chart, 1mmHg is 0.133322kPa, therefore 760mmHg will be 760×0.133322kPa=101.32472kPa.

# Pressure Sensor

## Specifications

Pressure type		Gauge pressure							
		Negative pressure type		Standard pressure type				Compound pressure type	
Model (★1)	Analog voltage output	PSAN-V01C(P)V		PSAN-01C(P)V		PSAN-1C(P)V		PSAN-C01C(P)V	
	Analog current output	PSAN-V01C(P)A		PSAN-01C(P)A		PSAN-1C(P)A		PSAN-C01C(P)A	
	Hold/Auto shift input	PSAN-V01C(P)H		PSAN-01C(P)H		PSAN-1C(P)H		PSAN-C01C(P)H	
Rated pressure range		0.0 ~ -101.3kPa		0.0 ~ 100.0kPa		0 ~ 1,000kPa		-101.3kPa ~ 100.0kPa	
Display pressure range		5.0 ~ -101.3kPa		-5.0 ~ 110.0kPa		-50 ~ 1,100kPa		-101.3kPa ~ 110.0kPa	
Min. display unit(internal resolution)		0.1kPa(1/2,000)		0.1kPa(1/2,000)		1kPa(1/2,000)		0.1kPa(1/2,000)	
Max. pressure range		2 times of rating pressure				1.5 times of rating pressure		2 times of rating pressure	
Applicable fluid		Air, Non-corrosive gas							
Power supply		12V-24VDC ±10% (Ripple P-P:Max. 10%)							
Current consumption		Max. 50mA (Analog Current Output type Max 75mA)							
Control output		<ul style="list-style-type: none"> <li>• NPN open collector output ☞ Max. sink current:Max. 100mA, Applied voltage:Max. 30VDC, Residual voltage:Max. 1V</li> <li>• PNP open collector output ☞ Max. source current:Max. 100mA, Residual voltage:Max. 2V</li> </ul>							
Hysteresis (★2)		Min. display range							
Repeat error		±0.2%F.S. ± Min. display range							
Response time		Selectable 2.5ms, 5ms, 100ms, 500ms, 1000ms							
Short circuit protection		Built-in							
Analog output (★3)	Voltage output	<ul style="list-style-type: none"> <li>• Output voltage:1-5VDC ±2% F.S.</li> <li>• Linear:Within ±1% F.S.</li> <li>• Output impedance: kΩ</li> <li>• Zero point:Within 1VDC ±2% F.S.</li> <li>• Span:Within 4VDC ±2% F.S.</li> <li>• Resolution:1/2,000(equal to display resolution)</li> <li>• Response Time:50ms</li> </ul>							
	Current output	<ul style="list-style-type: none"> <li>• Output current:4-20mA ±2% F.S.</li> <li>• Linear:Within ±1% F.S.</li> <li>• Zero point:Within 4mA ±2% F.S.</li> <li>• Span:Within 16mA ±2% F.S.</li> <li>• Resolution:1/2,000(equal to display resolution)</li> <li>• Response Time:70ms</li> </ul>							
Display method		4 digit LED 7segment							
Min. Display interval	pressure unit resolution	1000	2000	1000	2000	1000	2000	1000	2000
	kPa	0.1	0.1	0.1	0.1	1	1	0.2	0.1
	kgf/cm <sup>2</sup>	0.001	0.001	0.001	0.001	0.01	0.01	0.002	0.001
	bar	0.001	0.001	0.001	0.001	0.01	0.01	0.002	0.001
	psi	0.02	0.01	0.02	0.01	0.2	0.1	0.04	0.02
	mmHg	1	0.4					1	0.8
	inHg	0.1	0.02					0.1	0.03
mmH <sub>2</sub> O	0.1	0.1					0.2	0.1	
Characteristic of control output and display temp.		Max. ±0.5% F.S. of display pressure at 25°C within 0°C to 50°C ※Max. ±1% F.S. of display pressure at 25°C under -10°C							
Analog output temp. characteristic		Max. ±2% F.S. of display pressure at 25°C within 0°C to 50°C							
Dielectric strength		1000VAC 50/60Hz for 1 minute							
Insulation resistance		Min. 50MΩ (at 500VDC megger)							
Environment	Ambient temperature	-10°C to +50°C (at non-dew status)							
	Storage temperature	-20°C to +60°C (at non-freezing status)							
	Ambient humidity	30~80%RH							
	Storage humidity	30~80%RH							
	Vibration	1.5mm amplitude at frequency of 10 to 55Hz in each of X, Y, Z directions for 2 hours							
Protection		IP40(IEC specification)							
Material		Front case : PC, Rear case : PC, Pressure port : Nickel Plated Brass							
Wire		φ 4, 5P, Length:2m							
Approval		CE							
Weight		Approx. 80g							

\*F.S. : Rated pressure.

※(★1) (P) represents PNP output type models.

※(★2) In hysteresis output mode, detection difference is variable. ※(★3) It is allowed to select one analog output type only.

### ●Analog output voltage-Pressure characteristic

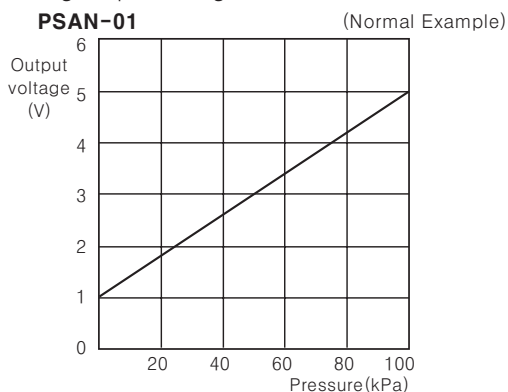

### ●Analog output voltage linear characteristic

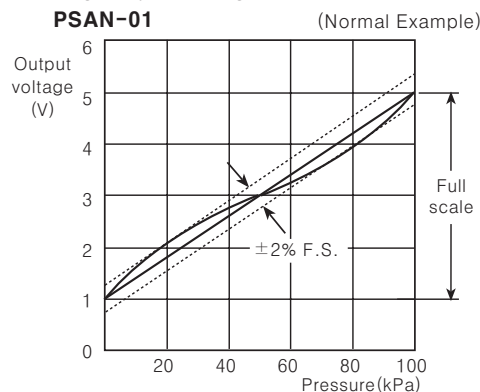

(A) Counter

(B) Timer

(C) Temp. controller

(D) Power controller

(E) Panel meter

(F) Tacho/Speed/Pulse meter

(G) Display unit

(H) Sensor controller

(I) Switching power supply

(J) Proximity sensor

(K) Photo electric sensor

(L) Pressure sensor

(M) Rotary encoder

(N) Stepping motor & Driver & Controller

(O) Graphic panel

(P) Field network device

(Q) Production stoppage models & replacement

# PSAN Series

## Dimensions

(Unit:mm)

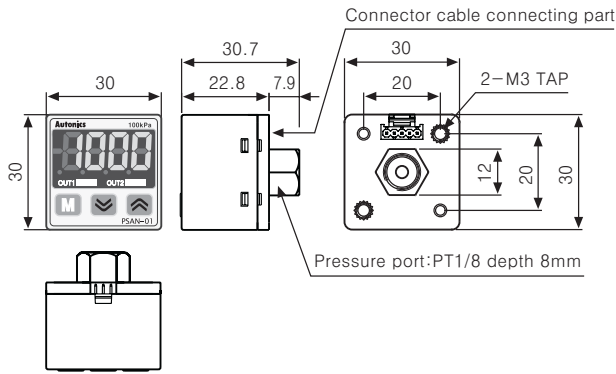

## Accessory

- Pressure unit label

±100kPa	-101.3kPa	2kPa	10kPa	100kPa	1MPa
±1.020kgf/cm <sup>2</sup>	-1.034kgf/cm <sup>2</sup>	2.040kgf/cm <sup>2</sup>	10.20kgf/cm <sup>2</sup>	1.020kgf/cm <sup>2</sup>	10.20kgf/cm <sup>2</sup>
±14.50psi	-14.70psi	29.00psi	145.0psi	14.50psi	145.0psi
±1.000bar	-1.013bar	2.000bar	10.00bar	1.000bar	10.00bar
±750mmHg	-760mmHg			/100	/100
±29.5inHg	-29.9inHg			X100	X100
±102.0mmH <sub>2</sub> O	-103.4mmH <sub>2</sub> O	2.040mmH <sub>2</sub> O	10.20mmH <sub>2</sub> O		

DISPLAY UNIT LABEL

- Bracket-A
- Bracket-B
- Connector cable(PSO-C01)

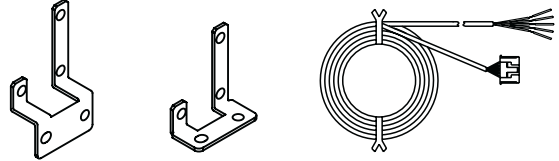

## Fixing bracket A for mounting

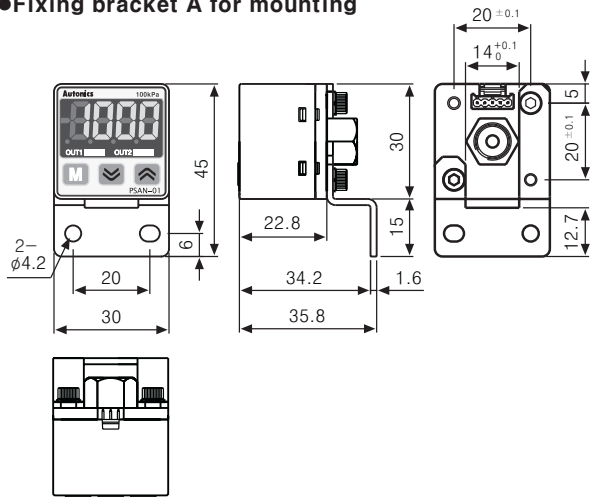

## Fixing bracket B for mounting

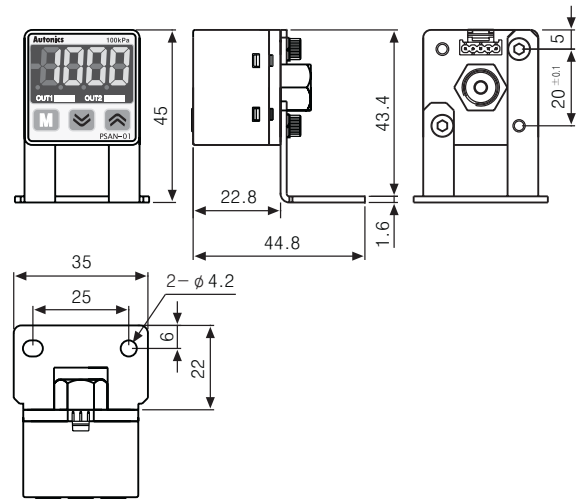

## Panel mounting bracket

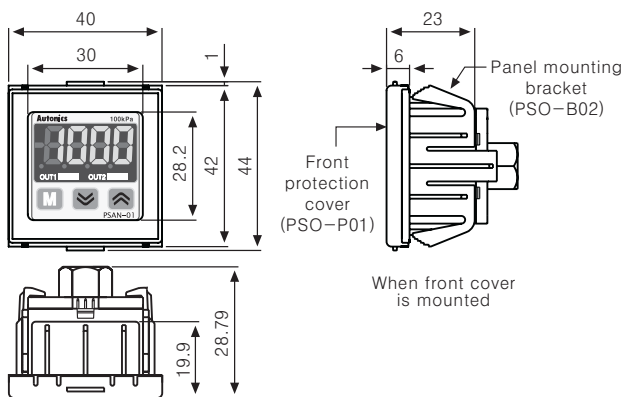

## Accessory (Sold separately)

- Panel cut-out

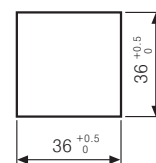

(Panel thickness : 0.8mm~3.5mm)

- Panel mounting bracket

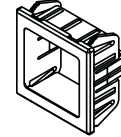

< PSO-B02 >

- Front protection cover

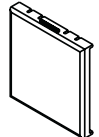

< PSO-P01 >

- M5 Gender



< PSO-Z01 >

## Bracket-A

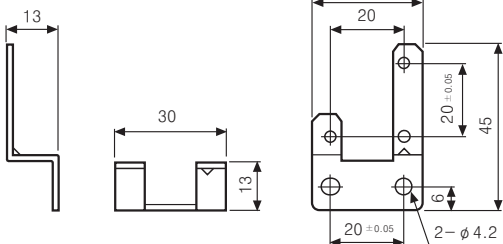

## Bracket-B

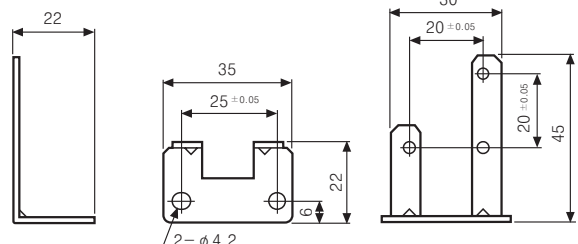

# Pressure Sensor

## Control output diagram

○ Analog output (Voltage output PSAN-□□□□V, Current output PSAN-□□□□A type)

● NPN open collector output type

● PNP open collector output type

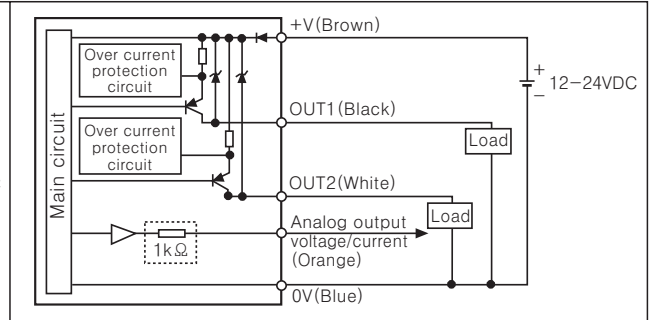
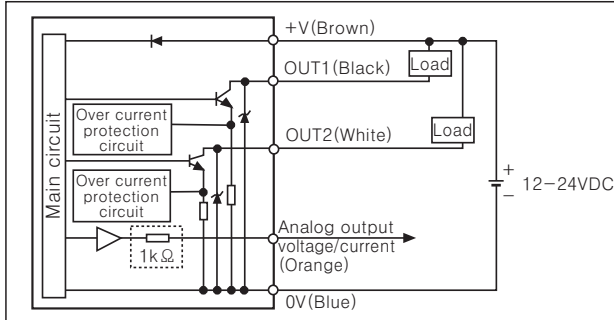

\* In case of analog voltage output type models short-circuit protection is not embodied. ( : For voltage output type only.)  
Do not connect with power source or load directly.

\* Be careful with input impedance of connecting devices when using analog voltage output type models.

\* Be careful with voltage drop due to cable's resistance when extending sensor's cable.

○ Hold/Auto shift input (PSAN-□□□□H type)

● NPN open collector output type

● PNP open collector output type

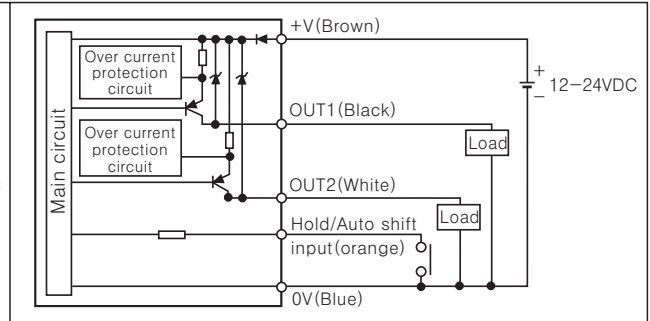
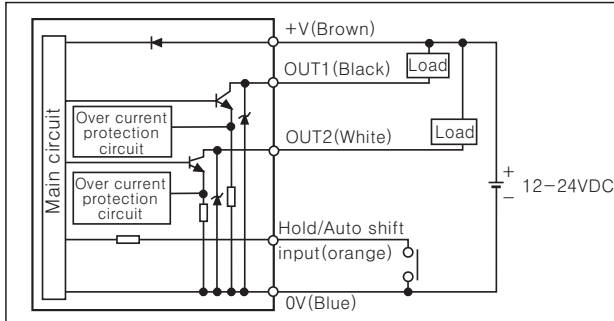

## Front panel identification

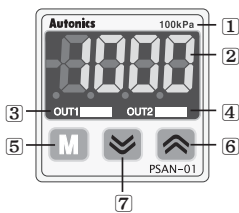

1 Range of rating pressure : It is possible to change the pressure unit in Pressure sensor. Please use different unit as label for your application.

2 4 digit LED display (Red) : Used to indicate measured pressure value, setting value and error message

3 Output1 indicator (Red) : Output 1 is ON, LED will be ON

4 Output2 indicator (Green) : Output 2 is ON, LED will be ON

5 M key : Used to enter into Preset/Parameter setting mode and to save Setting mode

6 ↑ key : Used to set the setting value to upper steps in preset mode and to display pressure unit, resolution, output mode, control output type, response time, analog output, Hold/Auto Shift, Key lock setting and High/Low Peak value in parameter setting mode

7 ↓ key : Used to set the setting value to lower steps in preset mode and to display pressure unit, resolution, output mode, control output type, response time, analog output, Hold/Auto Shift and Key lock setting in parameter setting mode

## Setting

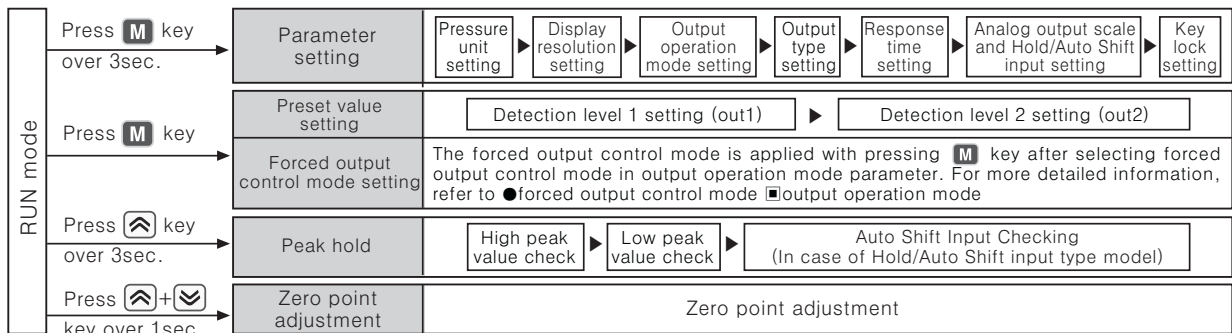

(A) Counter

(B) Timer

(C) Temp. controller

(D) Power controller

(E) Panel meter

(F) Tacho/Speed/Pulse meter

(G) Display unit

(H) Sensor controller

(I) Switching power supply

(J) Proximity sensor

(K) Photo electric sensor

(L) Pressure sensor

(M) Rotary encoder

(N) Stepping motor & Driver & Controller

(O) Graphic panel

(P) Field network device

(Q) Production stoppage models & replacement

# PSAN Series

## Zero point adjustment

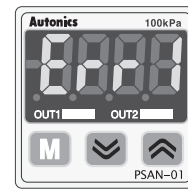
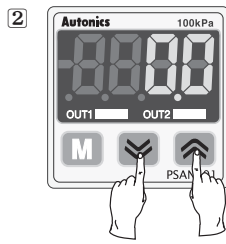
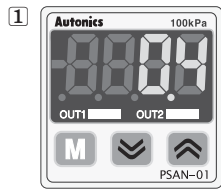

1. In state of atmospheric pressure during RUN mode, press key and key at the same time for over 1sec.
2. When the zero point adjustment is completed, it will display and return to RUN mode automatically.

\*Please execute Zero point adjustment regularly.

If executing zero point adjustment when external pressure has been applied, **Er1** will be flashing. Please execute Zero point again in state of atmospheric pressure.

## Parameter setting

1. Users can set pressure unit, display resolution, output operation mode, output type, response time, analog output scale, Hold—Auto Shift and key lock setting in parameter setting mode.
2. If the key lock is set (lock1 or lock2), unlock the key lock before setting parameters. (Refer to Key Lock setting below.)

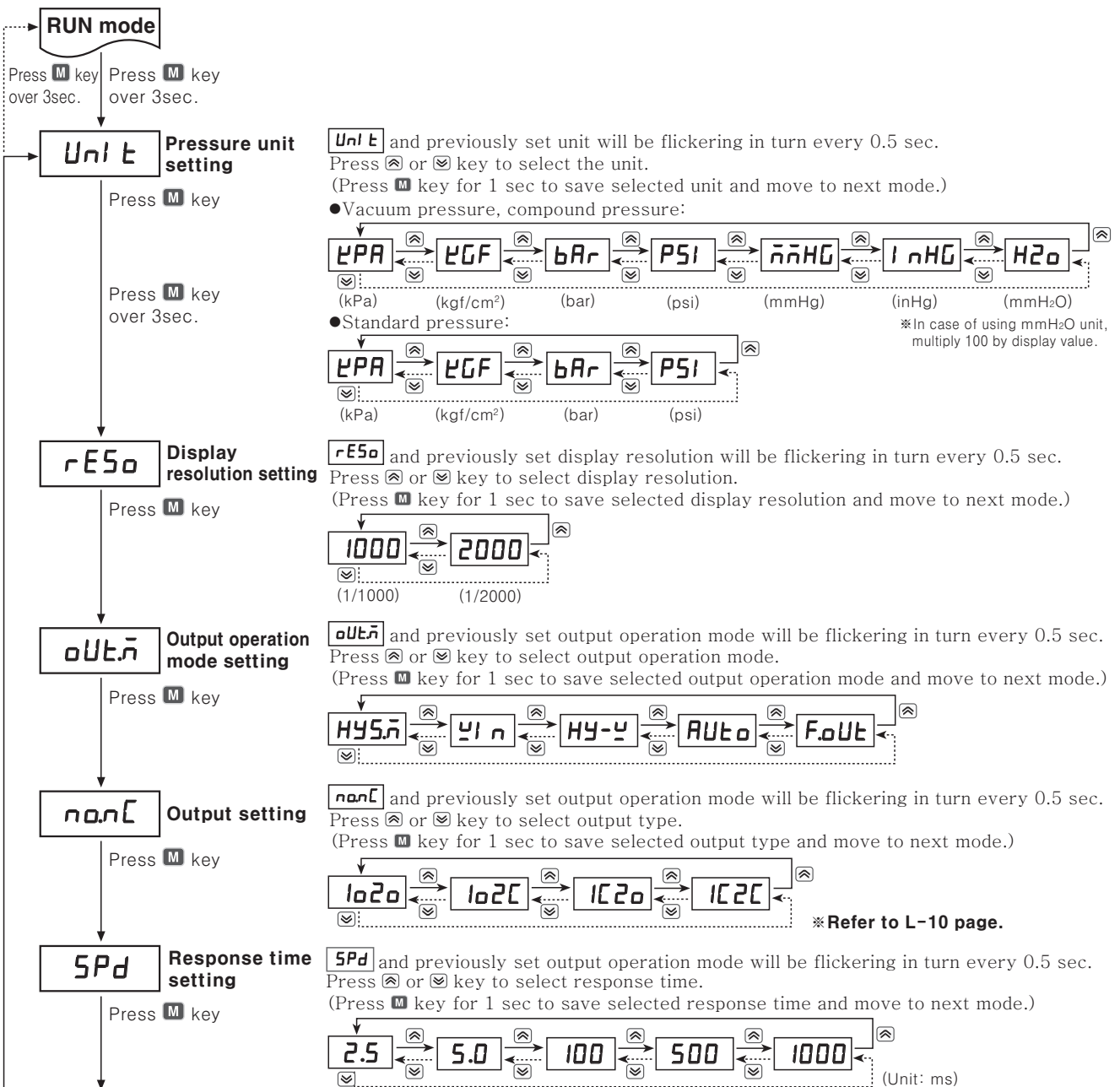

# Pressure Sensor

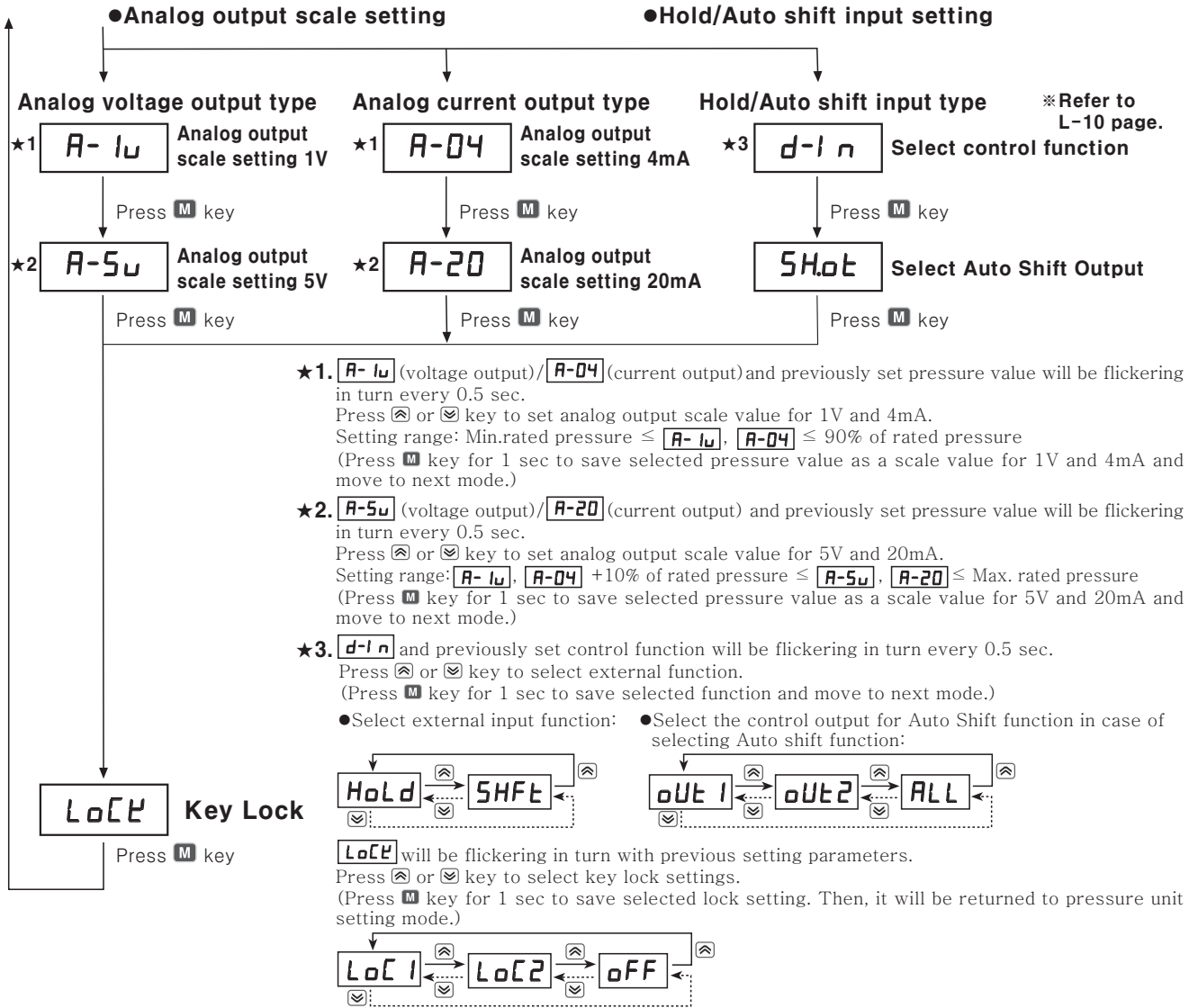

※ When pressing M key for 3 sec in the middle of parameter setting, current setting value will be saved in EEPROM and returned to RUN mode.  
 ※ All settings are saved in EEPROM regardless of power failure. Make sure that EEPROM has a limited write life cycle (100,000 times).

## ■ Preset setting

### ◎ Hysteresis mode(HY5.5)

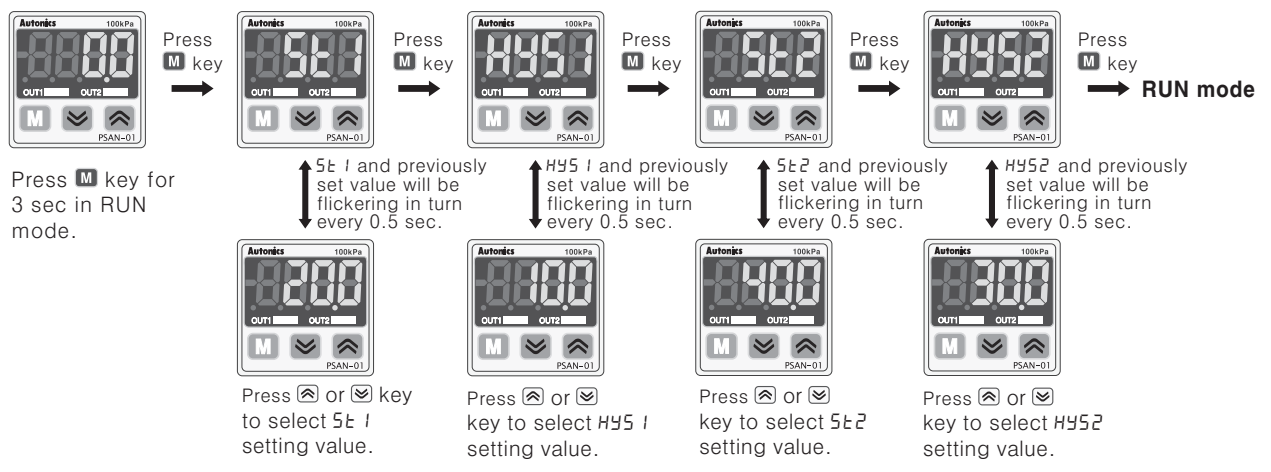

※ **5t1** setting range : Min. display pressure < **5t1** ≤ Max. display pressure  
 ※ **HY51** setting range : Min. display pressure < **HY51** ≤ **5t1**  
 ※ **5t2** setting range : Min. display pressure < **5t2** ≤ Max. display pressure  
 ※ **HY52** setting range : Min. display pressure < **HY52** ≤ **5t2**

- (A) Counter
- (B) Timer
- (C) Temp. controller
- (D) Power controller
- (E) Panel meter
- (F) Tacho/Speed/Pulse meter
- (G) Display unit
- (H) Sensor controller
- (I) Switching power supply
- (J) Proximity sensor
- (K) Photo electric sensor
- (L) Pressure sensor
- (M) Rotary encoder
- (N) Stepping motor & Driver & Controller
- (O) Graphic panel
- (P) Field network device
- (Q) Production stoppage models & replacement

# PSAN Series

## Window comparison output mode (ㄱㄴ)

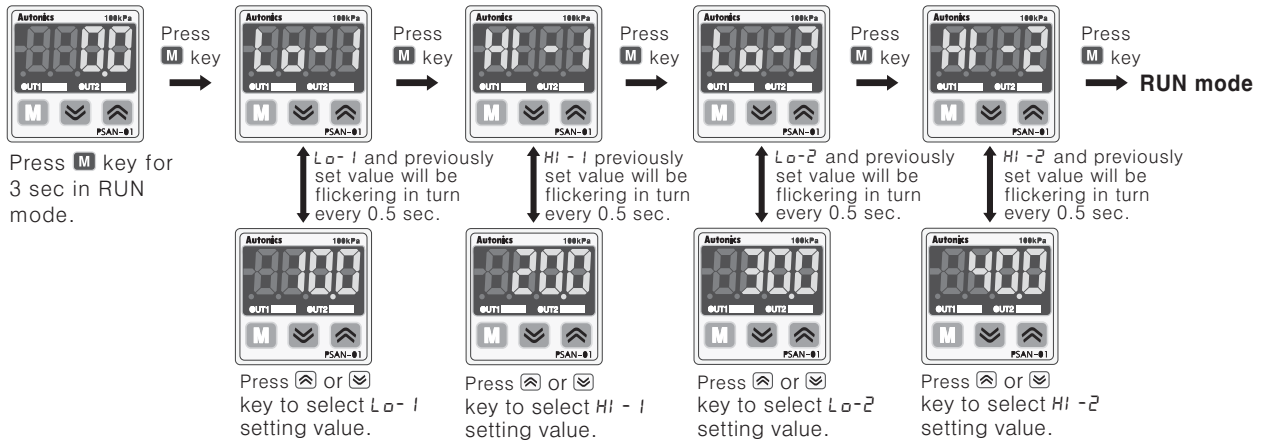

- ※Low value setting range : Min. display pressure < L0-1, L0-2 ≤ Max. display pressure - (3 × Min. display range)
- ※High value setting range : L0-1, L0-2 + (3 × Min. display range) ≤ HI-1, HI-2 ≤ Max. display pressure
- ※The minimum display unit for hysteresis is fixed to 1.

## Hysteresis-Window comparison output mode (ㄴㄷ)

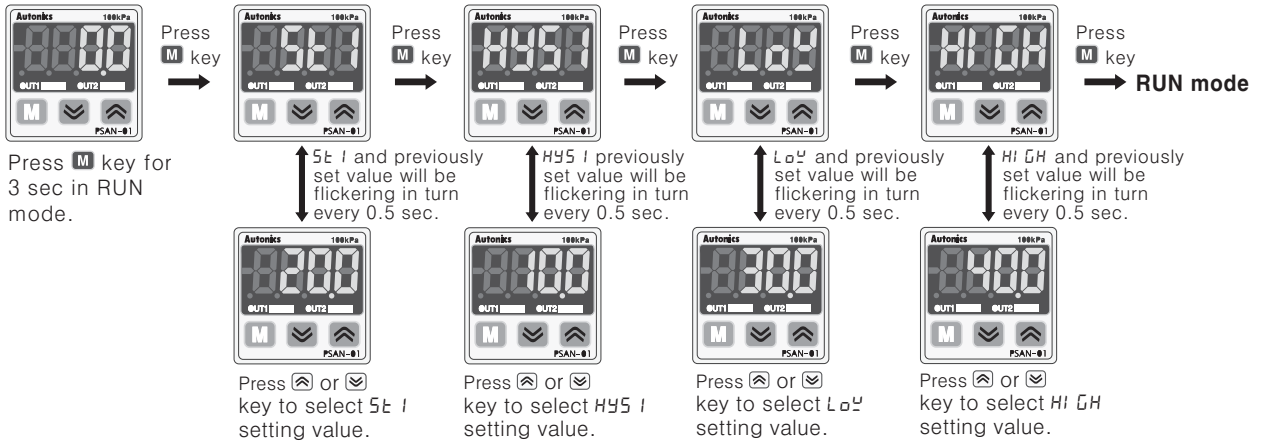

- ※5ㄷ I setting range : Min. display pressure < 5ㄷ I ≤ Max. display pressure
- ※HY5 I setting range : Min. display pressure < HY5 I ≤ 5ㄷ I
- ※Low value setting range : Min. display pressure < L0ㄷ ≤ Max. display pressure - (3 × Min. display range)
- ※High value setting range : L0ㄷ + (3 × Min. display range) ≤ HI ㄷH ≤ Max. display pressure
- ※In case HY5 I and 5ㄷ I have the same setting values, it will have the minimum display unit as a hysteresis.

## Automatic sensitivity setting mode (ㄹㄺㄻ)

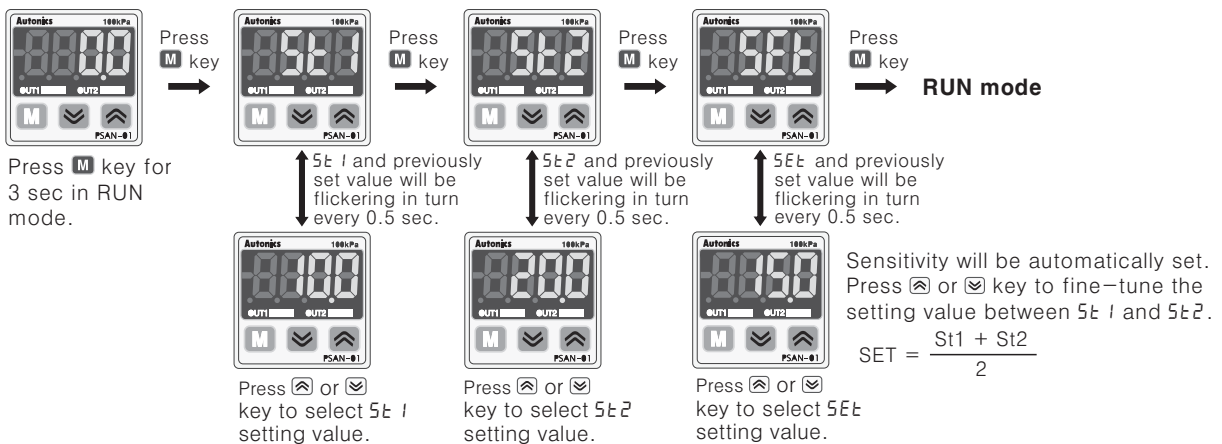

- ※5ㄷ I setting range : Min. display pressure ≤ 5ㄷ I ≤ Max. display pressure - 1% of rated pressure
- ※5ㄷ2 setting range : 5ㄷ I + 1% of rated pressure ≤ 5ㄷ2 ≤ Max. display pressure
- ※If certain detection level difference is not ensured, or setting conditions are not met, ERR3 message will be flickering three times and returned to 5ㄷ2 setting mode. Check all setting conditions and set proper setting values.
- ※Press **▲** key to change set values and last set value will be saved for level 1 and level 2.
- ※In case of PSAN-□□□□H type models, you can set 5ㄷ I and 5ㄷ2 using option input (yellow) after applying pressure on pressure port.

# Pressure Sensor

## ○forced output control mode(F.ouLt)

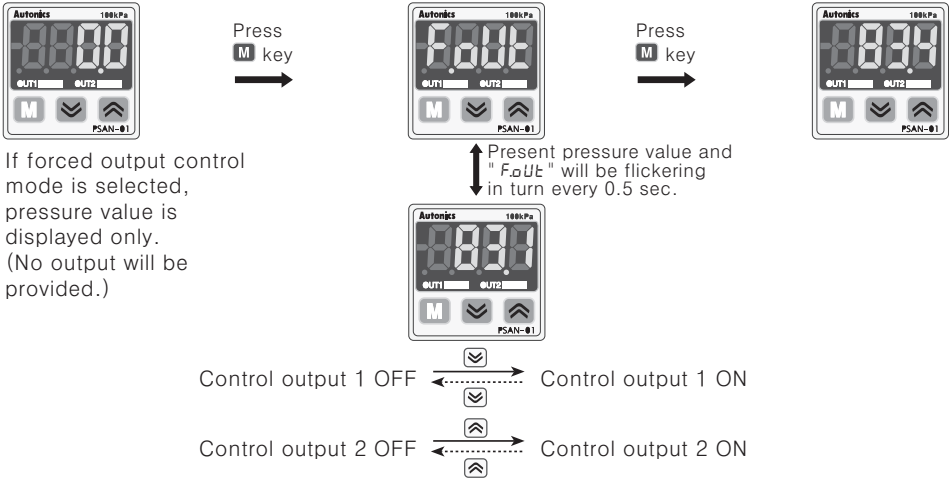

If forced output control mode is selected, pressure value is displayed only. (No output will be provided.)

- ※ If there is no additional key operation within 60 sec while setting, it is returned to Run mode (Except for force output mode). Previously set values are remained.
- ※ In case of changing output operation mode, no preset values will be initialized. Instead, previous output operation settings will become the preset values.
- ※ When changing pressure display unit, resolution and Hold/Auto Shift input function, preset values will be initialized as shown the table below. (When changing pressure display unit, preset value will be automatically switched to changed pressure unit.)
- ※ When using the forced output function, Hold/Auto shift function is not available to use in Hold/Auto shift mode.

## ●Preset Default

(Unit:KPa)

Output mode	Negative pressure -101.3~0	Standard pressure 0~100.0	Standard pressure 0~1,000	Compound pressure -101.3~100.0
HyS-n	SE 1:-50.0 HY5 1:0 SE 2:-50.0 HY5 2:0	SE 1:50.0 HY5 1:0 SE 2:50.0 HY5 2:0	SE 1:500 HY5 1:0 SE 2:500 HY5 2:0	SE 1:50.0 HY5 1:-50.0 SE 2:50.0 HY5 2:-50.0
Lo-n	Lo-1:-50.0 Hi-1:0 Lo-2:-50.0 Hi-2:0	Lo-1:0 Hi-1:50.0 Lo-2:0 Hi-2:50.0	Lo-1:0 Hi-1:500 Lo-2:0 Hi-2:500	Lo-1:-50.0 Hi-1:50.0 Lo-2:-50.0 Hi-2:50.0
Hy-y	SE 1:-50.0 HY5 1:0 Lo 1:0 Hi GH:-50.0	SE 1:50.0 HY5 1:0 Lo 1:0 Hi GH:50.0	SE 1:500 HY5 1:0 Lo 1:0 Hi GH:500	SE 1:50.0 HY5 1:-50.0 Lo 1:-50.0 Hi GH:50.0
Aut-o	SE 1:0 SE 2:-50.0 SE 3:-25.0	SE 1:0 SE 2:50.0 SE 3:25.0	SE 1:0 SE 2:500 SE 3:250	SE 1:-50.0 SE 2:50.0 SE 3:0

## ■High peak/Low peak function and Auto shift reference pressure check/change

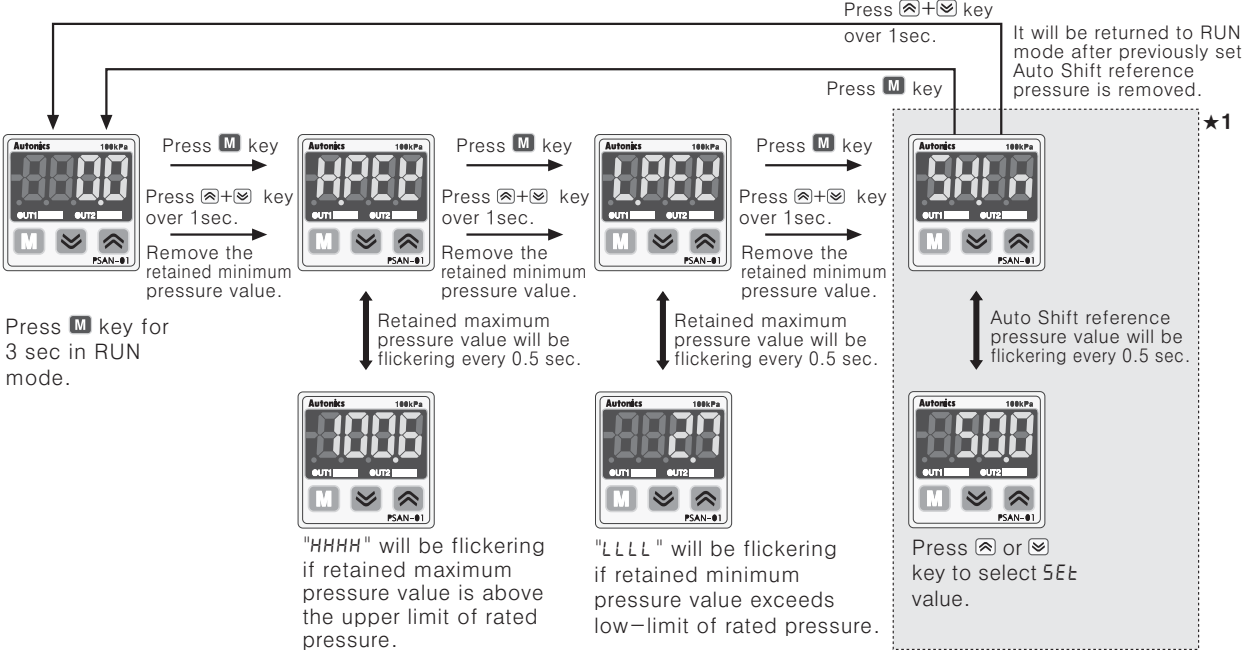

- ★1. ※Displayed only when "d-n" is set to "5HFt".(PSAN-□□□□H models only)  
 ※It is allowed to check / reset Auto Shift reference pressure only.  
 ※If there is no Auto Shift input, "0" will be displayed.(Refer to L-10 page for more details.)

(A) Counter

(B) Timer

(C) Temp. controller

(D) Power controller

(E) Panel meter

(F) Tacho/ Speed/ Pulse meter

(G) Display unit

(H) Sensor controller

(I) Switching power supply

(J) Proximity sensor

(K) Photo electric sensor

(L) Pressure sensor

(M) Rotary encoder

(N) Stepping motor & Driver & Controller

(O) Graphic panel

(P) Field network device

(Q) Production stoppage models & replacement



## Output operation mode

### 1. Hysteresis mode(HYS.̄)

It is able to set certain value for pressure detection level(5E1, 5E2) and hysteresis(HYS1, HYS2).

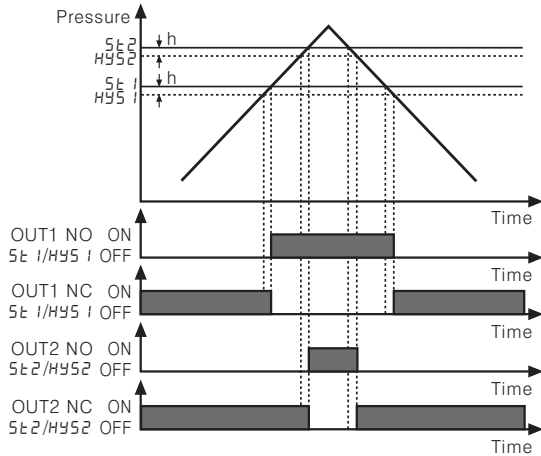

### 2. Window comparison output mode(̄U1̄)

- ① It is able to set the range for high(HI-1, HI-2), low(LO-1, LO-2) limit of pressure detection level when it is required to detect pressure at a certain range.
- ② Detection hysteresis is fixed to min. display range.

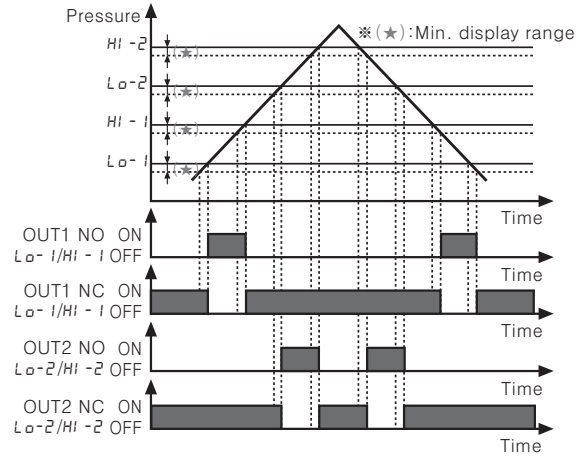

### 3. Hysteresis-window comparison output mode(HY-̄U)

- ① It is available to set hysteresis mode(5E1, HYS1) and window comparison output mode(LO-1, HI-1) are necessary.
- ② Detection hysteresis is fixed to min. display range.

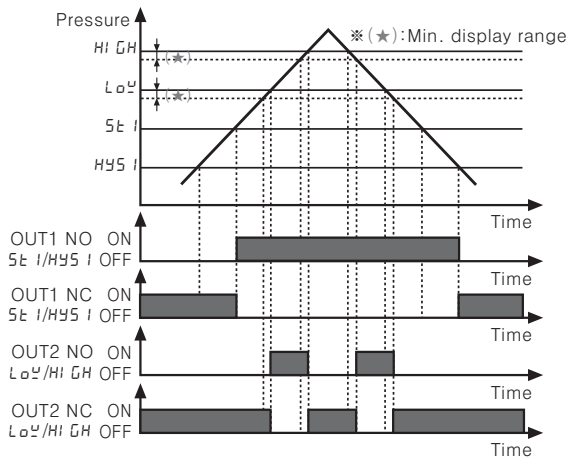

### 4. Automatic sensitivity setting mode(AUT.̄)

- ① This function is to set pressure detection level to the proper position automatically. It is set by applied pressure from two positions(5E1, 5E2).
- ② Detection hysteresis is fixed to min. display range.
- ③ The pressure detection level is shown in the following calculation.

$$SET = \frac{(St1 + St2)}{2}$$

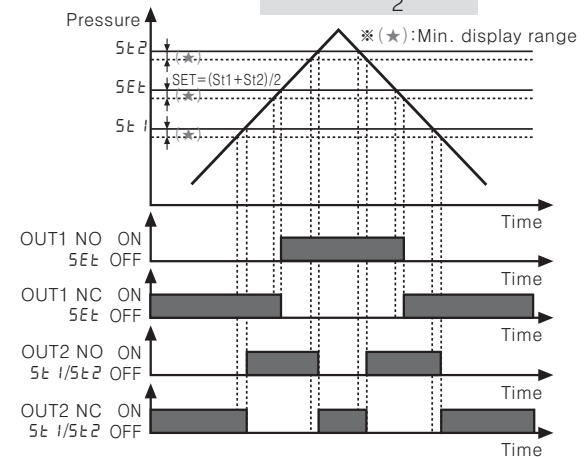

### 5. Forced output control mode(F.̄OUT)

- ① Used to display pressure with forcibly holding comparing output OFF regardless of setting value.
- ② Output 1, 2 can be ON/OFF manually by pressing key While the forced output control mode is applied.

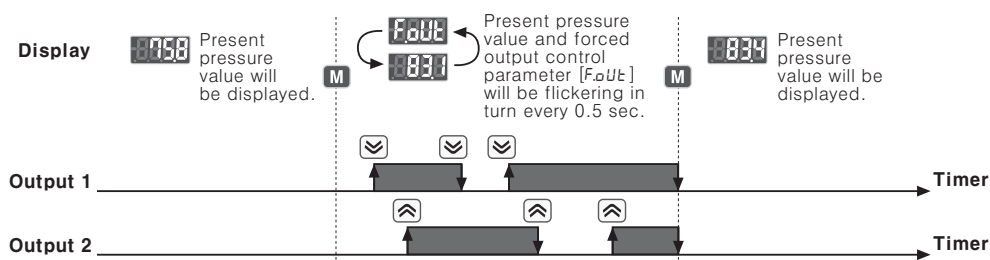

## ■ Functions

### ◎ Pressure unit change Function

PSAN-V01C(P) and PSAN-C01C(P) has 7 kinds of pressure unit, PSAN-01C(P) and PSAN-1C(P) has 4 kinds of pressure unit. Please select the proper unit for application.

- PSAN-V01C(P), PSAN-C01C(P) : kPa, kgf/cm<sup>2</sup>, bar, psi, mmHg, inHg, mmH<sub>2</sub>O
- PSAN-01C(P), PSAN-1C(P) : kPa, kgf/cm<sup>2</sup>, bar, psi
- ※ When using mmH<sub>2</sub>O unit, please multiply display value by 100.

### ◎ Display resolution change function

A function to select display resolution for measured pressure – 1/1,000 or 1/2,000  
Used when minimum display range is changed depending on pressure unit.

### ◎ Output mode change Function

There are 5 kinds of control output mode in order to realize the various pressure detection.

- Hysteresis mode (**HYS**) : hen needed to change hysteresis for detecting pressure.
- Window comparison output mode (**WIN**) : When needed to detect pressure in certain area.
- Hysteresis – Window comparison output mode (**HYS-WIN**) : When both hysteresis mode and window comparison output mode are required.
- Automatic sensitivity setting mode (**Auto**) : When needed to set detection sensitivity automatically at proper position.
- Forced output control mode (**Force**) : When needed to display pressure with remaining comparison output OFF regardless of setting value.

### ◎ Control output change function

Type of control output for Out1 and Out2 can be able to set Normal Open and Normal Close.  
※ Note that Normal Open and Normal Close provide opposite output.

OUT1 output	OUT2 output	Parameter setting value
Normal Open	Normal Open	[ 1020 ]
Normal Open	Normal Close	[ 1021 ]
Normal Close	Normal Open	[ 1120 ]
Normal Close	Normal Close	[ 1121 ]

### ◎ Response time change function (Chattering prevention)

It can prevent chattering of control output by changing response time. It is able to set 5 kinds of response time (2.5ms, 5ms, 100ms, 500ms, 1000ms) and if the response time is getting longer, the detection will be more stable by increasing the number of digital filter.

### ◎ Analog output scale setting function

- Analog voltage output scale setting : The scale function for analog output voltage (1–5VDC) is not fixed to the rated pressure range. It can be changed for User's application.
- Analog current output scale setting : The scale for analog output Current (4–20mADC) is not fixed to the rated pressure range. It can be changed for User's application.

### ◎ Hold/Auto shift setting function

- Hold function: A function to hold present pressure value and control output at the time of hold signal input  
※ Present pressure value and Hold message will be flickering in turn every 0.5 sec while HOLD function is set. Make sure that Hold function cannot be executed while forced output mode is executed.

#### ► Control output timing chart

EX) When Hold signal is applied in Hysteresis mode  
Refer to Control output diagram for hold signal input.

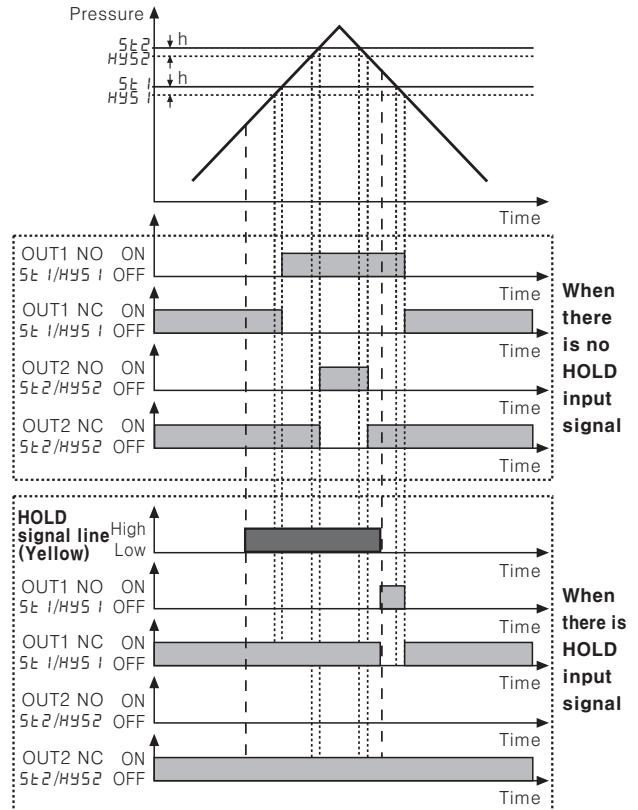

※ [ Hold ] and present pressure value will be flickering in turn every 0.5 sec while Hold signal is applied.

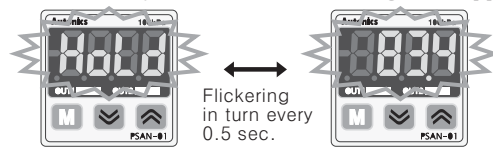

- Auto Shift function: A function to use the measured pressure at the moment of auto shift input as a reference pressure in order to correct the set point values of control output when initial pressure changes.  
※ Reference pressure is fixed to atmospheric pressure (0.0kPa) when Auto Shift function is not used.  
※ 5Hn (Auto Shift compensation value) will be reset to 0 when changing control output or preset values.  
※ Auto Shift function will not be executed if "HHHH", "LLLL" error occurs or if forced output mode is set.

- [ 5Hn ] : represents reference pressure change thru setting.
- [ 0Uk1 ] : represents that changed reference will be applied to control output 1 only.
- [ 0Uk2 ] : represents that changed reference will be applied to control output 2 only.
- [ RLL ] : represents that changed reference will be applied to both control output 1 and control output 2.

- (A) Counter
- (B) Timer
- (C) Temp. controller
- (D) Power controller
- (E) Panel meter
- (F) Tacho/ Speed/ Pulse meter
- (G) Display unit
- (H) Sensor controller
- (I) Switching power supply
- (J) Proximity sensor
- (K) Photo electric sensor
- (L) Pressure sensor
- (M) Rotary encoder
- (N) Stepping motor & Driver & Controller
- (O) Graphic panel
- (P) Field network device
- (Q) Production stoppage models & replacement

# PSAN Series

## ▶ When Auto Shift function is used

When Auto Shift input signal remains at low level more than 1ms, the measured pressure at this point will be saved as a reference value to make correct judgment regardless of pressure changes. Corrected preset pressure value will be applied after 7.5ms. Measured reference pressure value will be saved in [5H.I n].

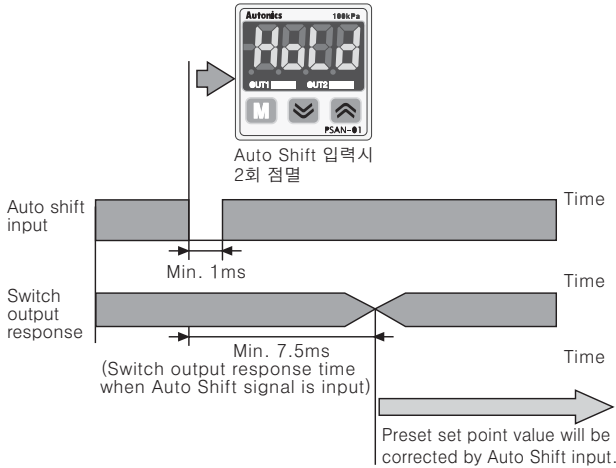

※ When Auto Shift function is used, the possible set pressure range will be wider than rated set pressure range.

※ The possible set pressure range for Auto Shift type models.

Pressure type	Set pressure range	Possible set pressure range for Auto Shift type models
Vacuum pressure	-101.3kPa~5.0kPa	-101.3kPa~101.3kPa
Standard pressure	-5.0kPa~110.0kPa	-110.0kPa~110.0kPa
	-50.0kPa~1100kPa	-1100kPa~1100kPa
Compound pressure	-101.3kPa~110.0kPa	-101.3kPa~110.0kPa

※ If the set point value corrected by auto shift input exceeds set pressure range, error message will be flickering three times and corrected value is not saved.

→ [-HH-] Displayed when the set point value corrected by auto shift input is above the upper limit of set pressure range

→ [-LL-] Displayed when the set point value corrected by auto shift input is below the lower limit of set pressure range

※ The correction value will be saved in EEPROM.

## ▶ Auto Shift Function Example

< When Auto Shift is not used >

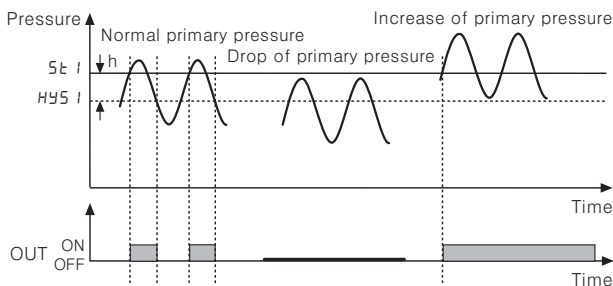

< When Auto Shift is used >

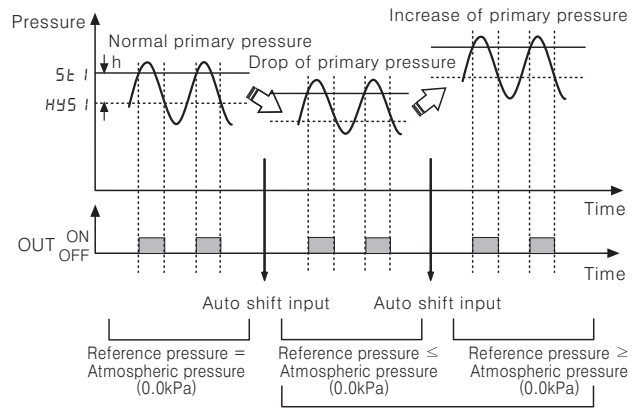

Correction set value: [5t I]' = [5t I] + [5H n]  
 Correction set value: [HY5 I]' = [HY5 I] + [5H n]  
 ※ [5H n] is the reference pressure set by Auto Shift input.

## ◎ Key lock function

The key lock function prevents key operations so that conditions set in each mode.

- **L0L1** : All keys are locked; therefore it is not available to change parameter settings, preset value, zero adjustment, High/Low peak check and SH.IN data initialization. (Lock setting change is available)
- **L0L2** : Partially locked status; therefore it is not available to change parameter settings only (Lock setting change is available). Other settings are still available.
- **OFF** : All of the setting is available, all keys are unlocked.

## ◎ Zero point adjustment function

The zero-point adjustment function forcibly sets the pressure value to "Zero" when the pressure port is opened to atmospheric pressure. When the zero adjustment is applied, analog output [Voltage or Current] is changed by this function.

## ◎ High Peak / Low Peak Hold function

This function is to diagnosis malfunction of the system caused by parasitic pressure or to check through memorizing the max./min. pressure occurred from the system.

## ◎ Error

Error display	Description	Countermeasures
Err 1	When external pressure is input while adjusting zero point	Try again after removing external pressure
Err 2	When overload is applied on control output	Remove overload
Err 3	When setting condition is not met in Auto sensitivity setting mode	Check setting conditions and set proper setting values
LLLL	When applied pressure exceeds Low-limit of display pressure range	Apply pressure within display pressure range
HHHH	When applied pressure exceeds High-limit of display pressure range	Apply pressure within display pressure range
-HH- -LL- -HL-	Auto shift correction error	Set the corrected setting value within setting pressure range.

# Pressure Sensor

## ■ Installation

1. Pressure port has two types, PT1/8 and NPT1/8, therefore be sure to use proper port when using one touch fitting. (NPT 1/8 is option)
2. Please connect it by using spanner(12mm) at the metal part in order not to overload on the body when connecting one touch fitting.
3. Two different fixing brackets are provided for PSAN model. Select proper one with considering your application environments.
4. At first, please unscrew hexagon wrench bolt and assemble the bracket on this unit by fixing hexagon the wrenchbolt.

**In this case, tightening torque of hexagon wrench should be max. 3N · m. It may cause mechanical trouble.**

### ⚠ Caution

**The tightening torque of one touch fitting should be Max.10N · m. It may cause mechanical trouble.**

5. Bracket(PSO-B02) and front protection cover (PSO-P01) are optional to sell. Please see the pictures for installation.

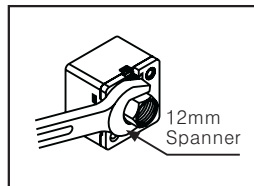
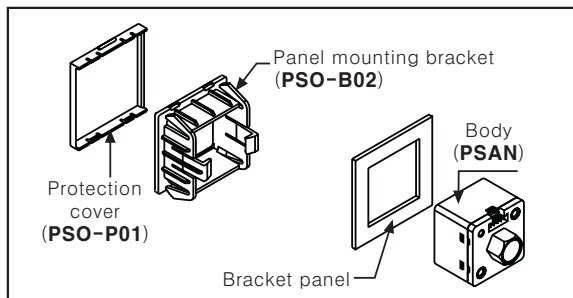

## ■ Proper usage

### ⚠ Caution

**PSAN Series is for sensing of non corrosive gas. Do not use this product at corrosive gas or flammable gas etc.**

- Please using this unit within range of specification, if applying pressure is larger than specification, it may not be working properly due to damage.
- After supplying power, it takes 3 sec. to work.
- When using switching regulator as power supply, it must be grounded(F · G).

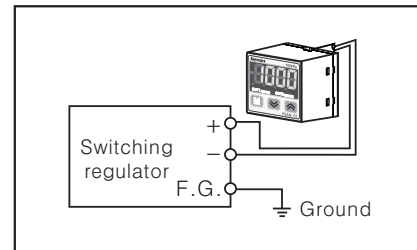

- It may cause malfunction by noise, when wiring with power line or high voltage line.
- Do not insert any sharp or pointed object into pressure port. It may cause mechanical problem due to sensor damage.
- Do not use this unit with flammable gas, this is not an explosion proof structure.
- Be sure that this unit should not be contacted directly with water, oil, thinner etc.

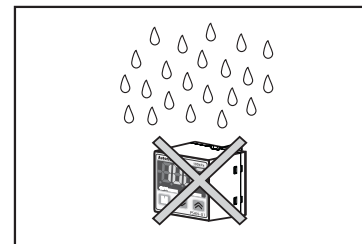

- Wiring must be done with power off.

(A)	Counter
(B)	Timer
(C)	Temp. controller
(D)	Power controller
(E)	Panel meter
(F)	Tacho/ Speed/ Pulse meter
(G)	Display unit
(H)	Sensor controller
(I)	Switching power supply
(J)	Proximity sensor
(K)	Photo electric sensor
(L)	Pressure sensor
(M)	Rotary encoder
(N)	Stepping motor & Driver & Controller
(O)	Graphic panel
(P)	Field network device
(Q)	Production stoppage models & replacement